



CONNECTION TOPOLOGY OPTIMIZATION OF STEEL MOMENT FRAMES USING GENETIC ALGORITHM

H. Tamjidi Saraskanroud^{1,*},[†] and M. Babaei²

¹*Department of Civil Engineering, University of Tabriz, Tabriz, Iran*

²*Department of Civil Engineering, University of Bonab, Bonab, Iran*

ABSTRACT

Structural topology optimization provides an insight into efficient designing as it seeks optimal distribution of material to minimize the total cost and weight of the structures. This paper presents an optimum design of steel moment frames and connections of structures subjected to serviceability and strength constraints in accordance with AISC-Load and Resistance Factor Design (LRFD). In connection topology optimizations, different beam and column sections and connections and also to optimize two steel moment frames a genetic algorithm was used and their performance was compared. Initially, two common steel moment frames were studied, only for the purpose of minimizing the weight of the structure and the members of structure are considered as design variables. Since the cost of a steel moment frame is not solely related to the weight of the structure, in order to obtain a realistic plan, in the second part of this study, for the other two frames the cost of the connections is also added to the variables. The results indicate that the steel frame optimization by applying real genetic algorithm could be optimal for structural designing. The findings highlighted the prominent performance and lower costs of the steel moment frames when different connections are used.

Keywords: Steel frame optimization, metaheuristic algorithms, connection topology optimization, genetic algorithm.

Received: 12 January 2023 Accepted: 23 May 2023

*Corresponding author: Department of Civil Engineering, University of Tabriz, Tabriz, Iran

[†]E-mail address: Hossein.tamjidi93@ms.tabriz.ac.ir (H. Tamjidi Saraskanroud)

1. INTRODUCTION

Structural optimization is the process of creating structures with the use of mathematical methods that efficiently optimize a certain objective function. The objective function could be to minimize weight or cost, reduce vibrations, maximize strength, or any other desired outcome. Structural optimization is a critical aspect of engineering design that has evolved significantly over the years [1, 2]. The first generation of structural optimization methods emerged in the 1960s and was based on mathematical programming techniques [3]. These methods were mainly used in the aerospace industry when there was a need to reduce weight while maintaining structural integrity. Later on, finite element analysis (FEA) was introduced in the 1970s, which allowed for a more detailed analysis of structures. This led to the development of topology optimization methods that seek to find the best layout of material in the structure [4, 5].

Topology optimization is a popular method in structural optimization as it can provide a broad range of results [6]. The topology optimization technique was introduced to minimize total costs by varying member sections and connection rigidities [2, 7, 8]. In this approach, structural designing can be optimized by redistributing structural material [9-11]. The connection topology optimization as an optimizing method refers to various beam-to-column connection types in a steel moment frame to specify the optimal arrangement of rigid and moment connections [12]. In topology optimization, material is removed or added from the structure to achieve the desired outcome. Designers can use the results of topology optimization to create structures that are more efficient and perform better [13, 14]. This has led to the development of optimization software that uses a combination of FEA and topology optimization methods [15]. Other methods that have been used in structural optimization include shape optimization, sizing optimization, and layout optimization. Shape optimization involves changing the shape of the structure to achieve the desired objective function. Sizing optimization involves changing the dimensions of the structure, while layout optimization involves changing the arrangement of components to optimize the objective function [16, 17].

In the previous decades, investigators have proposed various approaches to solve engineering optimization problems. The initial researches were often focused on application and development of classical gradient-based techniques. In these techniques, the starting point is considered as an essential factor and the search process is performed based on the gradient information related to the objective function [18, 19].

Premature convergence, sensitivity to initial solutions, high computational effort, and getting trapped in local optimal points are the most important disadvantages of gradient-based methods [20, 21]. Recently, meta-exploratory algorithms have been proposed as a suitable alternative to classical optimization methods. The general framework of meta-exploratory algorithms is often inspired by nature or a specific process.

These algorithms not only did not have the disadvantages of the previous methods, but they had a very acceptable performance compared to them. Meta-exploration algorithms have a simple structure and do not need specific information about the objective function. But despite the mentioned advantages, meta-exploratory algorithms do not always

guarantee to reach a general optimal solution [22, 23].

For this reason, researchers are looking for improved algorithm for engineering optimization problems. Optimum design algorithms in a random search can considerably minimize the weight of steel structures and provide economical and reliable structure designs [24-26]. Several algorithms have been developed recently such as: genetic algorithms, tabu search, particle swarm optimization and ant colony optimization [27-30]. The Genetic algorithm approach has been presented by Holland [31] and Goldberg [32] (1975) to solve optimization problems, with discrete variables without requirements on the continuity of design variables [33, 34]. GA is a search algorithm based on the mechanism of population genetics and natural selection of genetics and applies the principle of survival of the fittest to structure optimization and have been used in several studies for steel frame design optimization [35-38]. The GA comprises three principal components: reproduction, crossover, and mutation [39, 40]. In the first phase of the process, the population will be initialized to randomly develop a high-quality population. In the next step, two candidates or chromosomes from the population will be selected and considered as parents. Then the crossover is applied to two chromosomes where they produce offspring. The best-fitted offspring will be selected. Now by recombining the parts of the parents a new offspring will be produced. As a mutation, a modification will be made in the offspring to retain genetic diversity. In the next step, the generated offspring population will be substituted and the algorithm will be run till the designated candidate or chromosome will be viewed as a solution [12, 41-43].

The genetic algorithm approach has been successfully applied to many structural optimization problems. For example, in a study, a genetic algorithm was used to optimize the design of a composite plate. The results showed that the genetic algorithm was able to find a design that was 9% lighter than the original design while still meeting all the design requirements [44]. This has led to its widespread use in various fields, including civil engineering, mechanical engineering, and aerospace engineering.

2. METHODOLOGY

For analyzing material and structural properties Finite Element Analysis (FEA) technique was used and Direct Strength Method (DSM) applied to propose a designed recommendation. The critical buckling load also obtained by using Effective Length Method. For programming and computing data, MATLAB platform and, for verifying outcomes, Etabs software was used. All the results and outputs have been modeled and verified by the powerful ITBS software. Also, the computer system used has the following specifications: Fujitsu, Intel® Core™ i5-3210M CPU @ 2.50GHz. The formulation of the optimization problem (objective function type, used adverbs) will be described in below. As mentioned before, the finite element stiffness method is used for the analysis of the structure, and the general stiffness method, matrices and the formulation of the optimization problem (objective function type, used adverbs) are given and presented in accordance with the problem. Also, the design requirements have been mentioned. Also, the characteristics and topology of the structures that have been examined in this study will be presented.

In this research, a Genetic algorithm was used to optimize structures. First, we compared

the binary and real-type algorithms. Then we selected the real-type for analysis because, it created a more convenient connection between the concepts, no need for coding, more control over operators, better adjustment of the operator rates, higher convergence speed in reaching the optimal solution, and lower amount of structure analysis (generation) to achieve the desired solution rather than binary-types.

In the selection process, the roulette wheel method was applied. For the crossover step in the binary algorithm, respectively for one-point, two-point, and uniform, the probability of selection set on 0.1, 0.2, and 0.7. In the real-type algorithm, an intermediate or arithmetic cross over was applied. In Mutation step, for the binary-type multi-point mutation and for the real-type non-uniform mutation were used. The stopping criterion in this study is the maximum number of generations, which varies according to the type of problem, the number of iterations, and analysis structures. Table 1 presents Pseudo code of GA.

Table 1. Pseudo code of GA.

```

Create a random population of individuals (or chromosomes)
Set the crossover and mutation rates
Set  $k \rightarrow 1$ 
Compute the fitness function for each chromosome
While the termination conditions are not met
    Pick up some chromosomes from mating pool
    Apply crossover operators to the selected chromosomes
    Pick some chromosomes for mutation
    Apply Mutation operators to the selected chromosomes
    Identify elite chromosomes to pass them to the next generation
    Select the most fitted chromosomes to pass into new generation
    Evaluate new generation through fitness function
    Set  $k \rightarrow k + 1$ 
end while
Return the ever-best chromosomes detected by GA

```

Also Figure 1 shows flow chart of GA optimization.

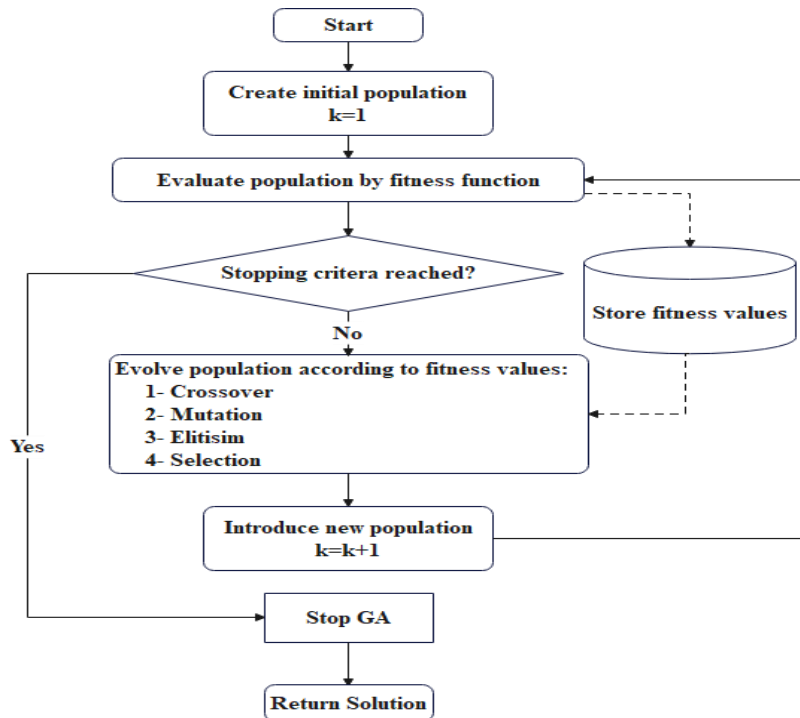

Figure 1- Flow chart of GA optimization

2.1 Optimization problem formulation

Optimization of steel moment frames and connection topology can be formulated as follows:

$$\begin{aligned} \min f(y) \\ g_i(y) \leq 0 \quad i = 1, \dots, m \end{aligned} \tag{1}$$

where:

F(Y) = objective function

Y={x,x_c} = given frame design in which

x = the W-shape sections assigned to frame members

x_c = the number of beam groups in the frame.

In present study, a beam-to-column connection can be either a rigid or a moment connection. Therefore, four types of beams are defined (Figure 2): (a) fully moment-connected (Type-1); (b) fully pinned (Type-2); (c) left-end moment- connected (Type-3);

and (d) right-end moment-connected (Type-4).

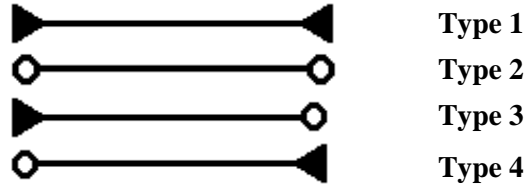

Figure 2. Beam types

Depending on the type of considered loading, inequality constraints limit the objective function.

For the wind and gravity loads constraints can be any combination of design strength, inter-story drift and constructability constraints. The design strength constraint equations are taken from AISC-LRFD [45] specifications as follows:

$$g_r^s(y) = \frac{P_{ur}}{\phi P_{nr}} + \frac{8}{9} \left(\frac{M_{uxr}}{\phi_b M_{nrx}} + \frac{M_{uyr}}{\phi_b M_{nyr}} \right) - 1.0 \leq 0 \quad \text{For } \frac{P_{ur}}{\phi P_{nr}} \geq 0.2 \quad (2)$$

$$g_r^s(y) = \frac{P_{ur}}{2\phi P_{nr}} + \left(\frac{M_{uxr}}{\phi_b M_{nrx}} + \frac{M_{uyr}}{\phi_b M_{nyr}} \right) - 1.0 \leq 0 \quad \text{For } \frac{P_{ur}}{\phi P_{nr}} < 0.2 \quad (3)$$

where:

$r = 1; \dots; n_{ele}$;

For members with tensile axial forces:

n_{ele} = the total number of beams and columns in a frame.

P_{ur} = the required tensile strength,

P_{nr} = the nominal tensile strength,

and $\phi = \phi_t$ = the resistance factor for tension.

For members with compressive axial forces:

P_{ur} = the required compressive strength,

P_{nr} = the nominal compressive strength,

$\phi = \phi_c$ = the resistance factor for compression

Also,

M_{uxr} = the required flexural strength about the major axis,

M_{uyr} = the required flexural strength about the minor axis,

M_{nrx} = the nominal flexural strength about the major axis,

M_{nyr} = the nominal flexural strength about the minor axis,

ϕ_b = the resistance factor for flexure

The inter-story drift constraints are given by:

$$g_r^d (y) = \left(\frac{\delta_r}{\delta_a} \right) - 1.0 \leq 0 \tag{4}$$

where:

$r = 1; \dots ; n_{st}$;

n_{st} = the number of stories,

d_r = the maximum drift at story

r , and d_a = the allowable story drift.

Also constructability constraints are expressed as follows:

$$g_r^c (y) = \left(\frac{b_{bf}}{b_{cf}} \right)_r - 1.0 \leq 0 \tag{5}$$

where:

$r = 1; \dots ; n_c$;

n_c = the total number of constructability constraints;

b_{bf} = the flange width of beam

b_{cf} = the flange width of column.

By using penalty functions and constrained problem a penalized unconstrained optimization problem can be presented as follows:

$$\min f_p (y) \tag{6}$$

$$f_p (y) = f (y) (1 + \alpha_s \beta_s (y) + \alpha_d \beta_d (y) + \alpha_c \beta_c (y)) \tag{7}$$

$$f (y) = W (x) + M (x_c) \tag{8}$$

where:

$f_p (y)$ = the penalized (unconstrained) objective function;

α_s = the penalty coefficient corresponding to strength violation,

α_d = the penalty coefficient corresponding to drift violation and

α_c = the penalty coefficient corresponding to constructability violation.

The cost function, $f(y)$, contains material cost and connection fabrication cost components. The cost of connections $M(x_c)$, material cost $W(x)$ and the auxiliary functions are defined as follows:

$$M (x_c) = CUC \cdot N_{mc} \tag{9}$$

$$W(x) = SUC \cdot \rho \sum_{j=1}^{n_g} \left[A_j \left(\sum_{i=1}^{m_j} L_i \right) \right] \quad (10)$$

$$\begin{aligned} \beta_s(y) &= \sum_{r=1}^{n_{ele}} \max[g_r^s(y), 0] \\ \beta_d(y) &= \sum_{r=1}^{n_s} \max[g_r^d(y), 0] \\ \beta_c(y) &= \sum_{r=1}^{n_c} \max[g_r^c(y), 0] \end{aligned} \quad (11)$$

where:

- $M(x_c)$ = the cost of connections,
- CUC = the connection unit cost
- N_{mc} = the number of moment connections in the frame.
- $W(x)$ = the portion of the cost due to the weight of steel;
- SUC = the steel unit cost,
- q = the density of steel,
- n_g = the total number of member groups with the same W-shape section assigned to all the members in a group,
- A_j = the member cross sectional area in group j ;
- m_j = the total number of members in group j ,
- L_i is the corresponding length of the member in a group.

2.2 Frames description

In this section, four frame structures are used for connection topology optimization using the GA in accordance with AISC-LRFD specifications. These examples include:

- A 2-bay 3-story moment frame;
- A 1-bay 8-story moment frame;
- A 5-bay 5-story moment frame;
- A 5-bay 10-story moment frame;

According to previous studies, the steel and connection unit costs are estimated to be \$600/metric ton and \$900/moment connection and, it is presumed that the cost of a moment connection will not significantly change the objective function value [12]. To express the cost of frame designs in terms of steel weight, a moment connection is equal to 1.5 metric tons of steel and the cost of pinned connections is considered to be zero.

2.2.1 The 2×3 Frame

For 2-bay 3-story steel frame, the modulus of elasticity and yield strength for all members of the structure are 200 GPa and 248 MPa, respectively, and the density of steel is 7850 kilograms per cubic meter.

The general goal of this design example is to minimize only the weight of the structure

by taking into account the constraints on the action of strengths according to Eq. (2) and (3) and the inter-story drift and constructability constraints are omitted, also the objective function is considered in the form of Eq. (7) in which the coefficient of the penalty function for the constraint of interaction strength = 2 is considered. In Eq. (8) for this problem, the cost of connections is omitted. The members of the structure are divided into two design groups with 9 columns and 6 beams. Beam sections are selected from 274 W-shaped wide wing sections. The sections of the columns selected from the wide wing sections with the characteristic W10, whose number is equal to 18. The topology and member groups of selected frame has been presented in Figure 3.

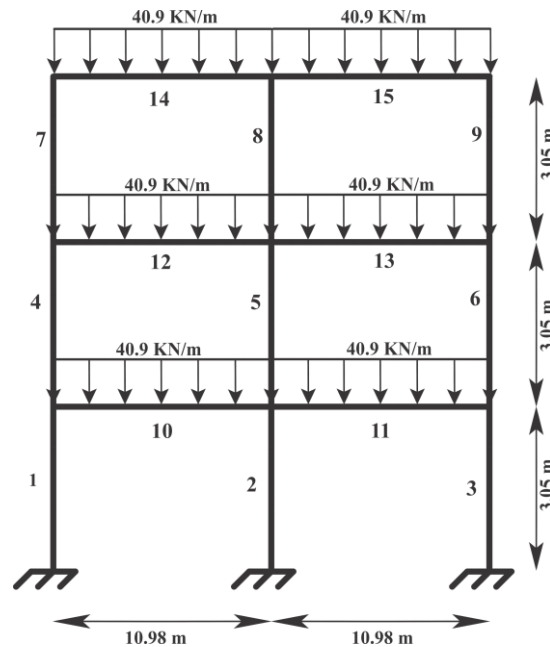

Figure 3. Topology and member groups of 2 × 3 frame

2.2.2 The 1×8 Frame

Figure 4 shows the 1-bay 8-story steel frame and the lateral loads on it. In addition to the loads shown in the figure, the vertical load KN 8.444 is introduced in all the connections of the structure. Due to implementation issues, a type of section is chosen for each of the columns and beams in two consecutive floors. The cross-sections of the structural members are selected from all 274 W-shaped wide wing sections, and the modulus of elasticity of the materials used and the yield strength for all the structural members are 200 GPa and 344.73 MPa, respectively, and the steel density is considered to be 7850 kg/m³.

In the example of 1-bay 8-story steel frame, the design is not concerned with the strength and construction constraint and only the overall displacement constraint of the structure is considered, which value should not be more than 5.08 cm. Also, the objective function is considered according to the Eq. (7), in which the coefficient of the penalty function for the displacement constraint is also included $a_d=2$, and in the Eq. (8) for this problem, the connection cost is omitted, $M(x_c)$ equal to Zero and only the goal is to minimize the weight of the structure (equal to 1) by satisfying the desired constraints. The topology and

member groups of selected frame has been presented in Figure 4.

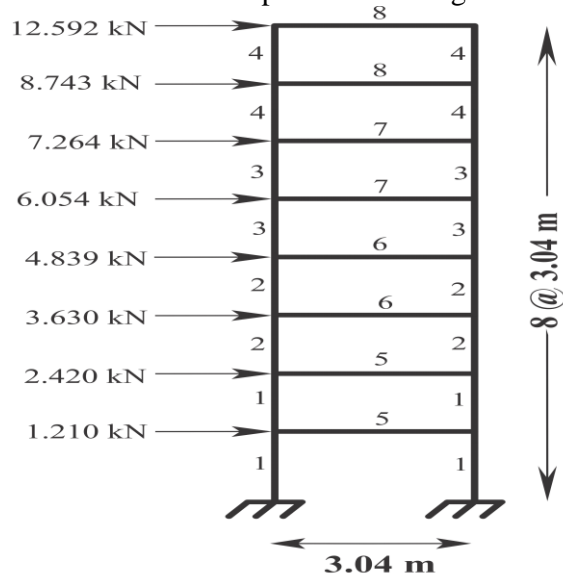

Figure 4. Topology and member groups of 1 × 8 frame

2.2.3 The 5×5 and 5×10 Frame

The topology and member groups of five-bay by five-story moment frame and five-bay by ten-story moment frame have been presented in Figure 5 and 6. For these frames examples A992 steel with $F_y = 344.7$ MPa have been used.

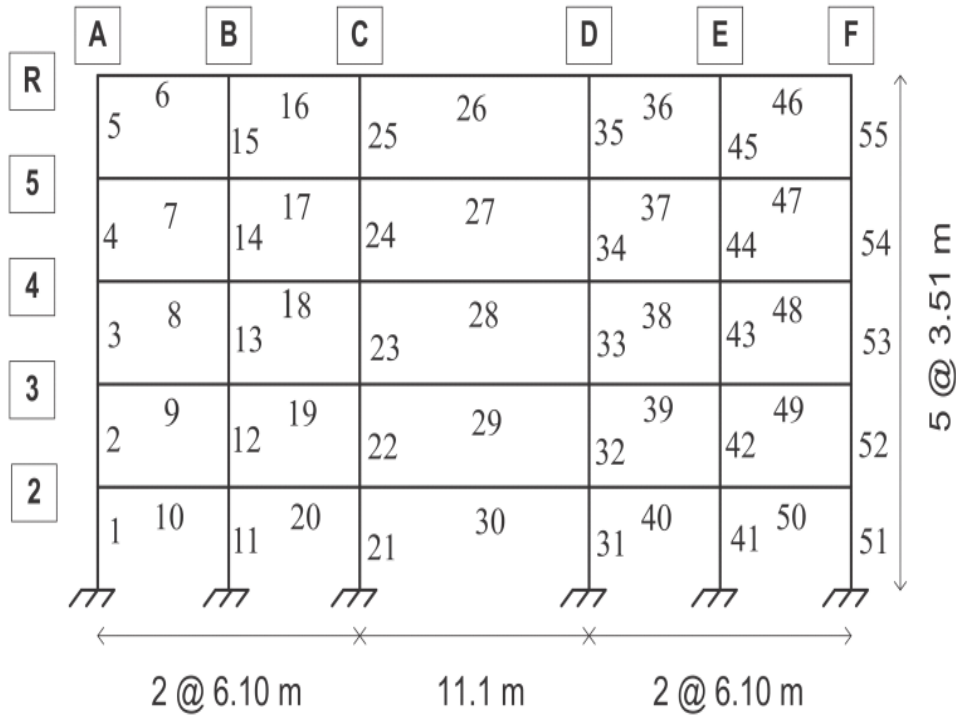

Figure 5. Elevation view of 5 × 5 frame

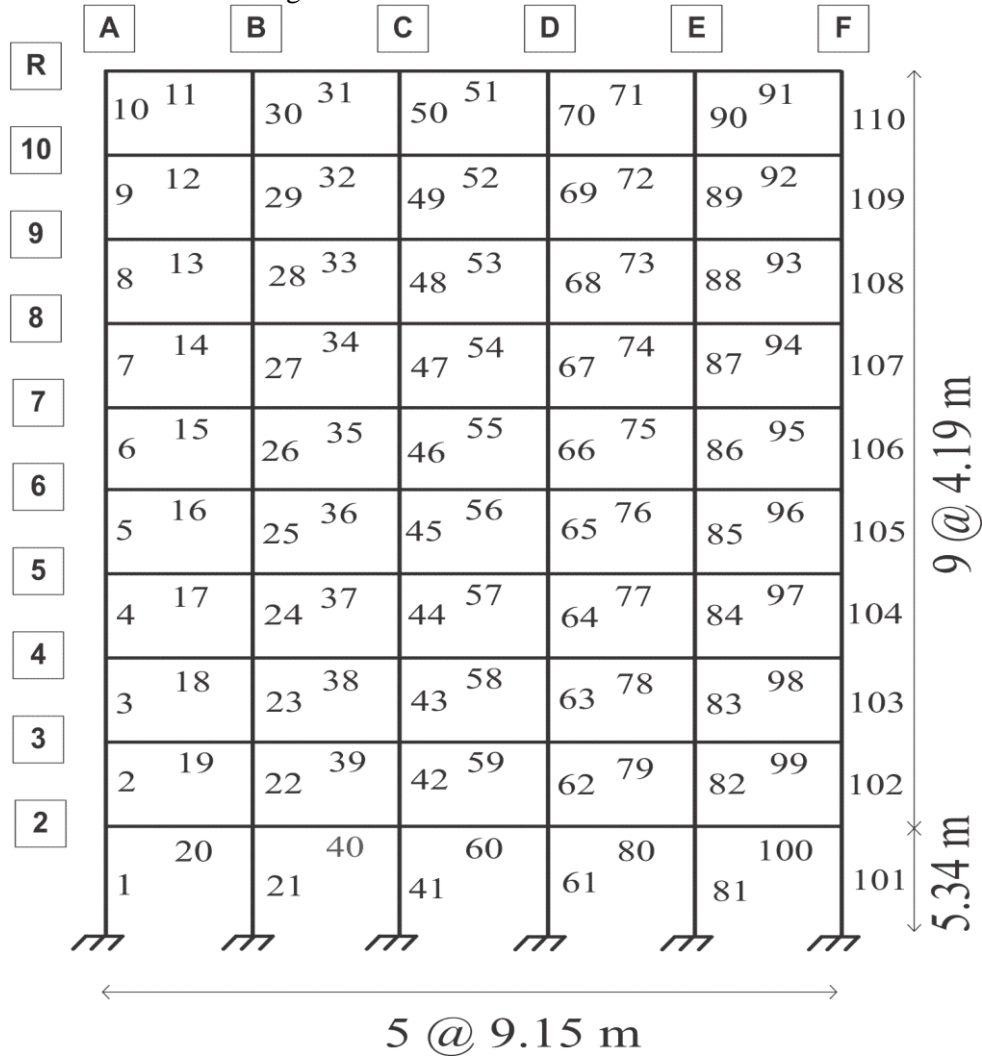

Figure 6. Elevation view of 5 × 10 frame

Also the applied loads are listed in table 2 and 3 for five-bay by five-story moment frame and table 4 and 5 for five-bay by ten-story moment frame.

Table 2. Distributed loads for 5 × 5 frame

| Load magnitude | Dead (kN/m) | Live (kN/m) |
|---------------------|---------------------|-------------|
| Ext. Bays Floor | 16.05 | 17.51 |
| Ext. Bays Roof | 4.38 | 2.77 |
| Central Bay Floor | 7.88 | 4.38 |
| Central Bay Roof | 1.17 | 2.77 |
| Exterior Bays Floor | Bays AB, BC, DE, EF | |
| | Stories 1–4 | |

Table 3. Point loads for 5×5 frame

| Load magnitude | Dead [41] | Live [41] | Wind[41] |
|------------------|-------------|-----------|----------|
| Live [41] | 44.9 | 26.7 | – |
| Wind[41] | 6.67 | 17.1 | – |
| Lines A, F Floor | 64.1 | 106.8 | – |
| Lines A, F Roof | 26.7 | 68.3 | – |
| Lines B, E Floor | 195.3 | 202.4 | – |
| Lines B, E Roof | 50.4 | 129.5 | – |
| Lines C, D Floor | – | – | 64.2 |
| Lines C, D Roof | – | – | 32.1 |
| Line A Floor | Stories 1–4 | | |

Table 4. Point and distributed loads for 5×10 frame

| Load magnitude | Dead | Live |
|-------------------------------------|----------------------|------|
| Floor Dist. Load (kN/m) | 5.55 | 3.65 |
| Roof Dist. Load (kN/m) | 4.09 | 1.46 |
| Floor Point Load – Ext. Column [41] | 26.5 | 17.3 |
| Floor Point Load – Int. Column [41] | 51.9 | 33.9 |
| Roof Point Load – Ext. Column [41] | 19.8 | 7.83 |
| Roof Point Load – Int. Column [41] | 38.5 | 14.5 |
| Floor | Stories 2–10 | |
| Exterior | Column Lines A, F | |
| Interior | Column Lines B,C,D,E | |

Table 5. Equivalent static wind loads at column line A for 5×10 frame

| Story | Load [41] |
|-------|-----------|
| 2 | 107 |
| 3 | 103 |
| 4 | 109 |
| 5 | 114 |
| 6 | 119 |
| 7 | 122 |
| 8 | 126 |
| 9 | 129 |
| 10 | 132 |
| Roof | 67 |

Table 6. Initial beam variable space for 5×5 frame connection topology optimization

| Beam sections | | | |
|---------------|--------|--------|---------|
| W10×12 | W16×40 | W24×68 | W33×130 |
| W12×14 | W18×35 | W24×76 | W36×135 |
| W12×16 | W18×40 | W24×84 | W36×194 |
| W12×19 | W21×44 | W27×84 | W40×149 |
| W12×22 | W21×48 | W30×90 | W40×167 |
| W12×26 | W21×50 | W30×99 | W40×183 |

| | | | |
|--------|--------|---------|---------|
| W14×22 | W21×55 | W30×108 | W40×199 |
| W14×26 | W24×55 | W30×116 | W40×211 |
| W16×26 | W24×62 | W33×118 | W40×215 |
| W16×31 | | | |

The load combinations used for both moment frames are similar. The beam sections have been presented in table 6.

For 5×5 frame and 5×10 frame structures the total size of the design space are $1.82E+54$ and $4.76E+66$ possible design permutations respectively. Strength is constrained with LRF axial-flexural interaction, and inter-story drift is constrained at a maximum of $H=400$. The penalty factors used for 5×5 frame are $a_s = 8$, $a_d = 4$ and $a_c = 4$ and for 5×10 frame considered as $a_s = a_d = a_c = 2$. Every beam is assumed to be continuously braced along its length. The following load combinations are applied:

- (a) $1.4D$
- (b) $1.2D + 1.6L + 0.5L_r$
- (c) $1.2D + 1.6W + 0.5L + 0.5L_r$

Where:

- D = the dead load,
- L = the live load,
- L_r = the roof live load
- W = the wind load.

Due to the random nature of the algorithms, the proposed algorithm was implemented 30 times in the examples of 3-story and 8-story moment frame design and 50 times in the examples of 5-story and 10-story moment frame design. Also, the maximum number of structure analysis times is selected as the stop criterion and this value is 800 for the first design example, 4500 for the second design example, 10000 for the third design example, and 20000 for the last design example. The population size for the first design example is 20, for the second design example it is 30 and for the third and fourth design examples it is 50. Also, for all design examples, the rate of integration and mutation is considered 0.8 and 0.4, respectively.

3. RESULTS

3.1 The 2×3 Frame

As mentioned before, in this example of 2-bay 3-story steel frame, the goal is only to minimize the weight of the structure according to the satisfaction of the constraints, and the topology optimization of the connections is not considered.

Table 7 compares the optimization results by different methods. As can be seen, the optimal design found by this method is lighter than GA [46], ACO [47], HS [35] and TLBO [48] methods. It should be noted that the number of structural analysis of this method, in reaching the best solution, was significantly less compared to other methods. Also, the standard deviation related to the presented method compared to GA [46], ACO [47] and HS

[35] methods is significantly small and only higher than the value of TLBO [48] method. The weight of the structure obtained in the TLBO [48] is more, and also in this method, the number of 1600 structure analysis has been considered as a stopping criterion. While for the proposed algorithm, half of this value, i.e. 800 structural analyses, is considered as a stopping condition. In addition, the algorithm presented in structure analysis was less than the TLBO [48].

Figure 7 shows the convergence curve related to the best result among 30 execution times. The presented algorithm succeeds in finding the optimal design (weights in kN) in almost most cases after 400 times of structural analysis. Figure 8 is related to the final results of 30 independent executions of the genetic algorithm, except for 5 times, it can be seen that the optimal plan has been reached in the rest of the executions, and as can be seen, the worst solution is related to the execution It is 24, which is equal to 79.45 kN (17853 lb), which is less than the best solutions of GA [46], ACO [47] and HS [35]. Figure 9 also shows the values of the strength interaction ratio in the members of the structure, the lowest ratio is related to member number 8 and the highest is related to members 2, 14 and 15.

Table 7. Optimization results of 2×3 frame

| Element group | Pezeshk <i>et al.</i> [46] | Camp <i>et al.</i> [47] | Degertekin [35] | Togan [48] | This study |
|-----------------|----------------------------|-------------------------|-----------------|------------|------------|
| | GA (binary) | ACO | HS | TLBO | GA |
| 10-19 (Beams) | W24×62 | W24×62 | W21×62 | W24×62 | W24×62 |
| 1-9 (Columns) | W10×60 | W10×60 | W10×54 | W10×49 | W10×45 |
| Weight (lb) | 18792 | 18792 | 18292 | 17789 | 17453 |
| Meanweight(lb) | 22080 | 19163 | 18784 | 17796 | 17513 |
| SD (lb) | 5818 | 1693 | 411 | 28.58 | 133.85 |
| No. of analyses | 900 | 880 | 853 | 480 | 800 |

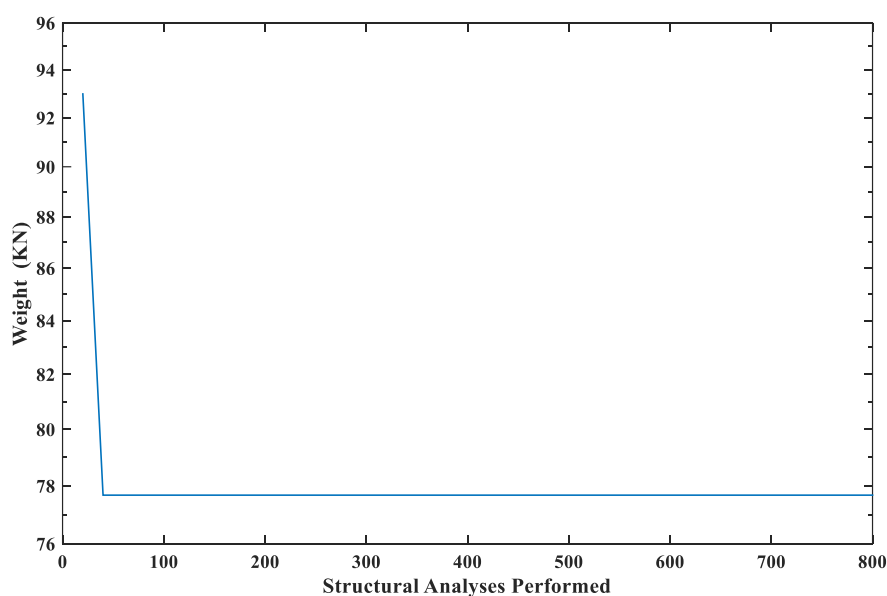

Figure 7. Convergence histories related to the best results of 2×3 frame

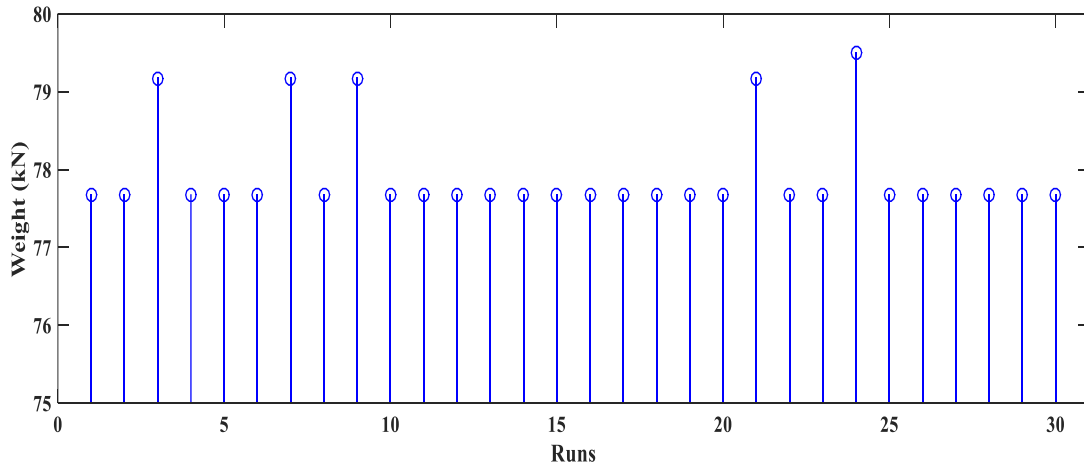

Figure 8. final results of 30 executions of the genetic algorithm in 2×3 frame

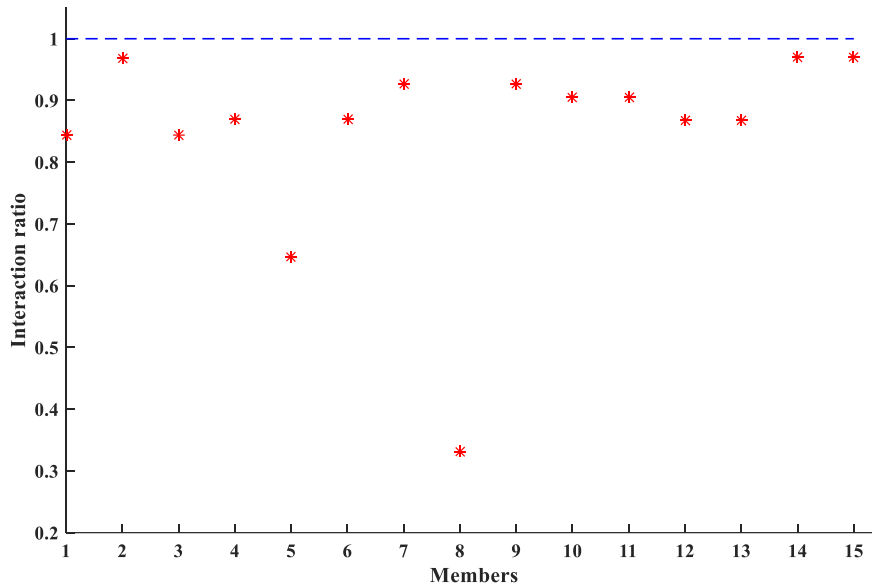

Figure 9. Members strength interaction ratio of 2×3 frame

3.2 The 1×8 Frame

In 1-bay 8-story steel frame, the goal was only to minimize the weight of the structure according to the satisfaction of the constraint, and the topology optimization of the connections is not taken into account.

Table 8. Optimization results of 1×8 frame

| Element group | | Khot et al.[49] | Camp et al [50] | Kaveh and Shojaee [51] | This study |
|---------------|-------|-----------------|-----------------|------------------------|------------|
| Type | Story | | GA | ACO | GA |
| 5 Beam | 1-2 | W21×68 | W18×35 | W16×26 | W21×44 |
| 6 Beam | 3-4 | W24×55 | W18×35 | W18×40 | W18×40 |

| | | | | | |
|-----------------|-----|--------|--------|--------|--------|
| 7 Beam | 5-6 | W21×50 | W18×35 | W18×35 | W18×35 |
| 8 Beam | 7-8 | W12×40 | W16×26 | W14×22 | W14×22 |
| 1 Column | 1-2 | W14×34 | W18×46 | W21×50 | W18×35 |
| 2 Column | 3-4 | W10×39 | W16×31 | W16×26 | W16×26 |
| 3 Column | 5-6 | W10×33 | W16×26 | W16×26 | W16×26 |
| 4 Column | 7-8 | W8×18 | W12×16 | W12×14 | W16×26 |
| Weight (lb) | | 41.02 | 32.83 | 31.68 | 32.61 |
| No. of analyses | | N/A | N/A | 4500 | 4500 |

Table 8 shows the optimization results of different methods for this structure. As can be seen, the presented algorithm has been able to gain less weight than its similar algorithm (GA [49, 50]), but it is heavier than the ACO algorithm [51]. The structure analysis value is set to 4500 and the most optimal design can be achieved in the structure analysis of 3420. The weight of the structure in this case is 61.32 kN. In the optimal design presented, the maximum displacement of the structure is equal to 5.02 cm. Also, Figure 10 shows the convergence curve related to the best solution.

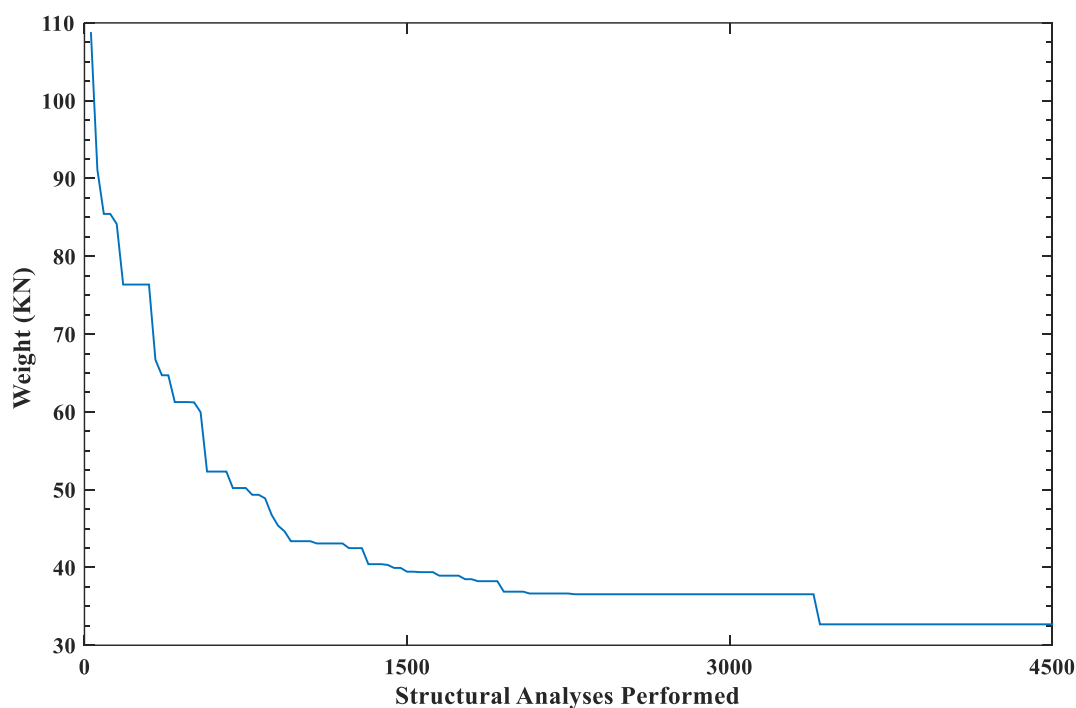

Figure 10. Convergence histories related to the best results of 1×8 frame

As seen in these two frames, the presented genetic algorithm has the best performance compared to other algorithms and according to the obtained results; it has good validation and is considered suitable.

3.3 The 5×5 Frame

In this frame, the goal is to minimize the cost of the structure by considering the cost related to the weight of the frame and the cost of beam-to-column connections. The results related to this frame have been examined and compared in two examples. In both examples, in addition to the cost related to the weight of the structure, the cost related to the connections is also considered and optimizing the topology of connections has been taken into account.

3.3.1 The 5×5 Frame with rigid connection

This frame has been checked by using the real genetic algorithm and considering all the connections as rigid, and also the cost design related to beam-to-column connections has been taken into account. For example, in this frame, there are 50 beam-to-column rigid connections, which, including the cost of each clamp connection, the total cost of the connections is equal to: \$45,000=900.50.

Figure 11 is related to the best results of the algorithm, in this figure, the sections of the beams are shown on the left side of the frame and on each of the beams, and the sections corresponding to each column are on the right side, which is shown in this way according to the symmetry of the structure. Considering that the weight of the structure for this frame is equal to 16.81 tons (18.53 metric tons), and the total cost of the structure is equal to \$56123.7.

Here the results are reported in metric tons for better comparison with other methods. The cost of the structure for the moment frame with fully moment connections is equal to 93.53 metric tons. Table 9 compares the results of connection topology optimization by different methods. As can be seen, the presented algorithm (true GA) in this study has achieved a lighter optimal design with less standard deviation compared to GA (binary) algorithm [12] and compared to other algorithms, the design is heavier. Of course, it should be noted that the number of executions for the proposed algorithm is half of the number of other methods. Figure 12 shows the curve related to the best result and Figure 13 shows the strength interaction ratio of the structural members of 5×5 frame5 moment frame with fully moment connections, considering the optimization of the connection topology.

Table 9. Comparison of the connection topology optimization results of 5×5 moment frame with fully moment connections

| Costs(\$ reported in metric tons | Alberdi <i>et al.</i> [12] | | | | This study GA |
|----------------------------------|----------------------------|-------|-------|-------------|---------------|
| | ACO | TS | HS | GA (binary) | |
| Min. Cost (\$) | 93.2 | 90.7 | 91.1 | 94.2 | 93.53 |
| Avg. Cost (\$) | 95.2 | 92.6 | 91.8 | 99.5 | 94.51 |
| Std. Cost (\$) | 0.54 | 0.99 | 0.24 | 2.42 | 1.23 |
| No. of analyses | 10000 | 10000 | 10000 | 10000 | 10000 |
| No. of runs | 100 | 100 | 100 | 100 | 50 |

Cost: 93.53 Metric Tons

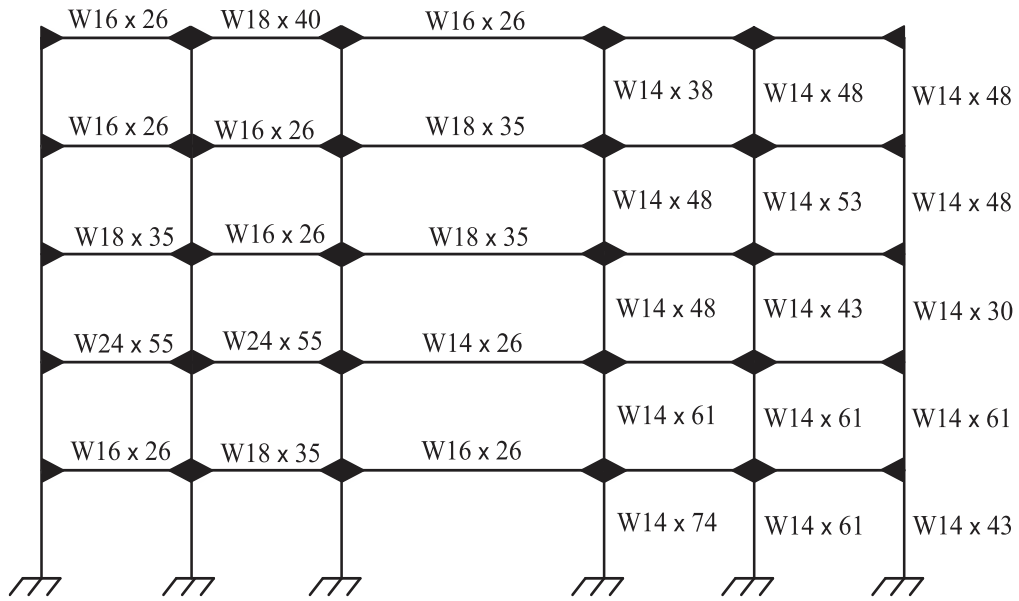

Figure 11. The best design of the 5×5 moment frame with fully moment connections, considering the optimization of the connection topology

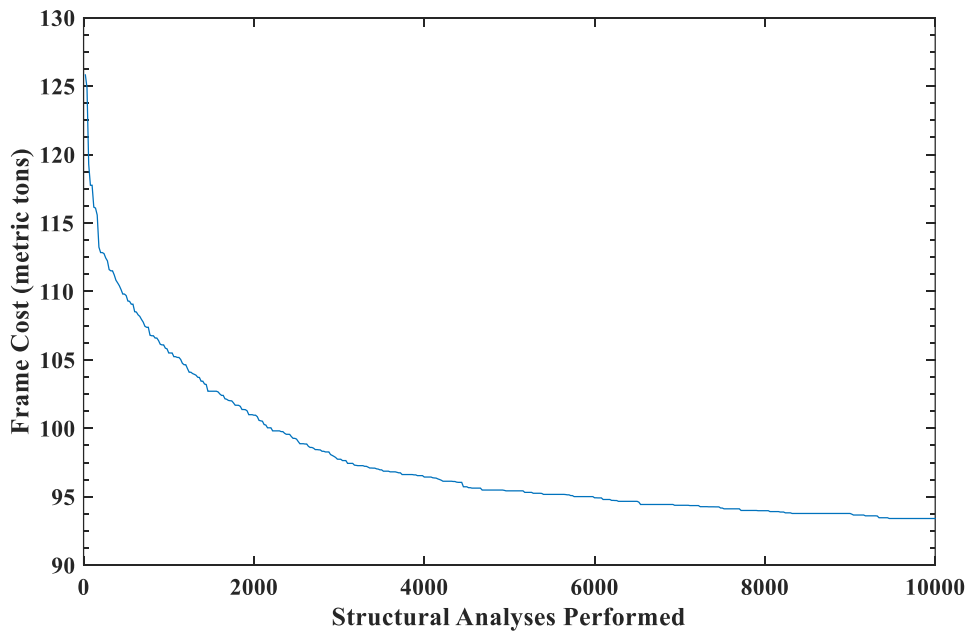

Figure 12. Convergence histories related to the best results of 5×5 frame with fully moment connections

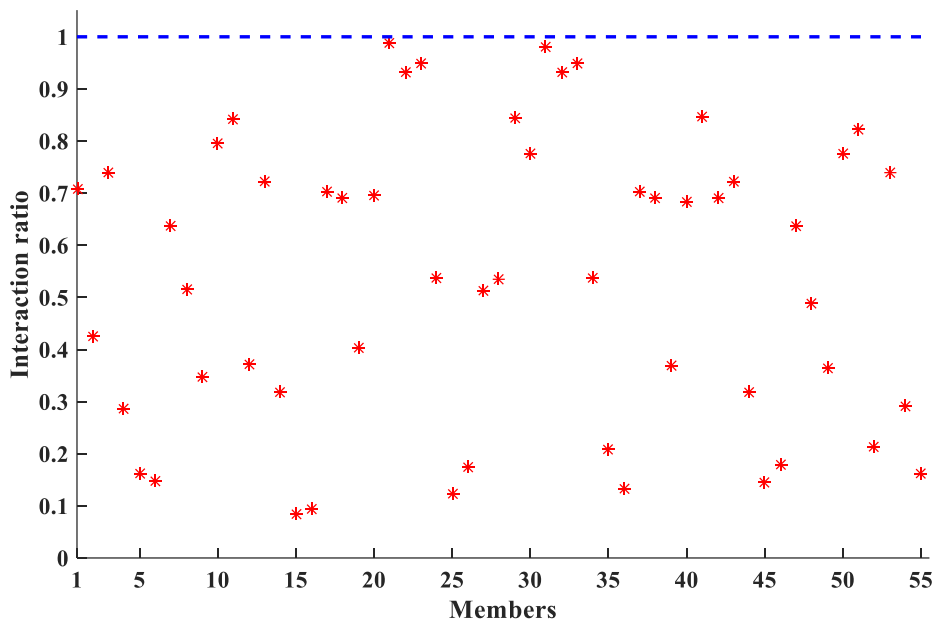

Figure 13. Members strength interaction ratio of 5×5 frame with fully moment connections

3.3.2 The 5×5 Frame with variable connection topology

The second example is related to the 5×5 moment frame with various connections and using the GA algorithm in a binary and real form, taking into account all the constraints. In the previous case, only the real genetic algorithm was used for the optimization of the 5×5 frame, but here, in addition to the fact that various connections are considered, also to compare the GA algorithm in the binary and real domain, from both The algorithm mode is used. At first, these two modes were used in such a way that in Crossover and Mutation steps in figure 20 and 21, genetic algorithm by two pools have been used: one for the member sections and another for the beam types. Then in the third case (figure 22), the real genetic algorithm has been used due to the better results compared to the binary one. In this one, three pools have been used: for the sections related to the members, the side beam connections type, and the central beam connections type.

- First mode: Binary GA - in two pools of mutation and integration - considering all constraints

- Second mode: Real GA - in two pools of mutation and integration - considering all constraints

- The third mode: Real GA - in three pools of mutation and integration - considering all constraints

Table 10 shows the results of connection topology optimization. By comparing the three methods, it can be concluded that the use of the real genetic algorithm with three pools for mutation and integration provides an optimal and less expensive design than the other approaches, and also the average and the standard deviation obtained in this case is also less than the other ones. So, the use of real GA offers a relatively less expensive design than the binary one, and in general, using the real GA algorithm in 3 pools of mutation and integration is more efficient and gives more optimal designs.

Table 10. Comparing optimization results for 5×5 frame with variable connection topology

| Costs(\$) reported in metric tons | Alberdi <i>et al.</i> [12] | | | | This study | | |
|---|----------------------------|-------|-------|-------------|------------|------------|------------|
| | ACO | TS | HS | GA (binary) | GA (case1) | GA (case2) | GA (case3) |
| Min. Cost (\$) | 36.2 | 37.8 | 44.8 | 38.8 | 38.92 | 38.31 | 36.26 |
| Avg. Cost (\$) | 46.4 | 45.5 | 48.9 | 45.5 | 45.6 | 45.8 | 42.3 |
| Std. Cost (\$) | 4.39 | 5.3 | 1.89 | 3.27 | 3.29 | 3.42 | 2.65 |
| No. of analyses | 10000 | 10000 | 10000 | 10000 | 10000 | 10000 | 10000 |
| No. of runs | 100 | 100 | 100 | 100 | 50 | 50 | 50 |

Figures 20, 21, and 22 are related to the best 5×5 moment frame design with various connections for modes 1, 2, and 3, respectively. As can be seen in Figure 22 related to the third mode, the number of receiver connections has been reduced from 50 to 8 by considering the optimization of the connection topology, and as a result, the cost of connections for this mode has been significantly reduced. On the other hand, due to satisfying the mentioned constraints and creating stability and lateral stiffness of the structure, the cross-sections of the members will be heavier compared to the case where all the connections are rigid, and the weight of the structure itself will increase, which is equal to 26/24 metric tons, but considering the cost related to the weight of the structure and the cost related to the connections as a whole, the cost of the structure significantly has been reduced compared to the case where all the connections are rigid and topology optimization is not considered.

Convergence histories and Members strength interaction ratio of 5×5 frame with variable connection topology including all constraints presented in figure 14 and 15 as binary genetic algorithm on two pools, figure 16 and 17 as real genetic algorithm on two pools and figures 18 and 19 as real genetic algorithm on three pools.

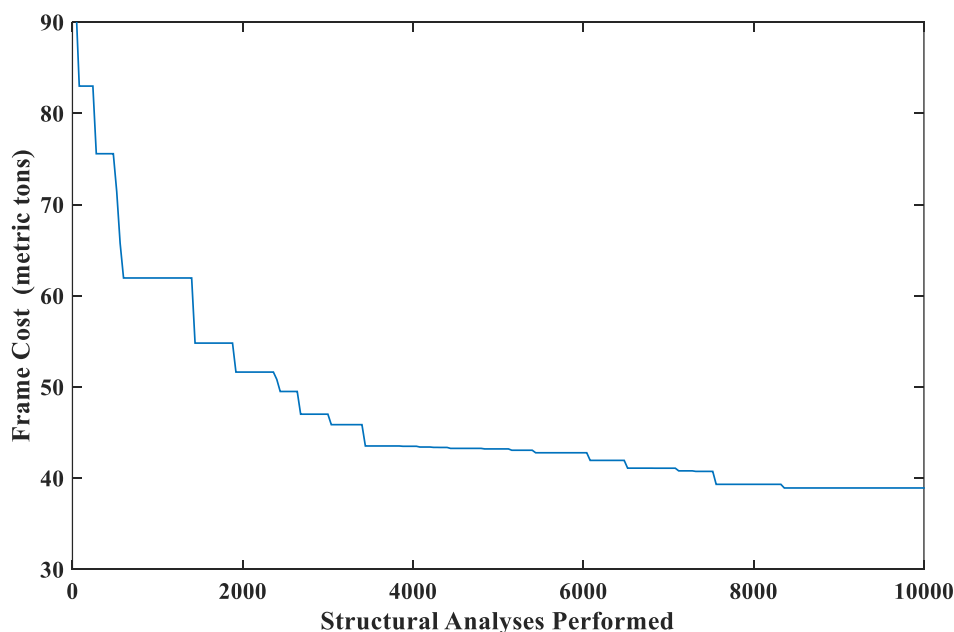

Figure 14. Convergence histories related to the best results of 5×5 frame with variable connections for mode 1

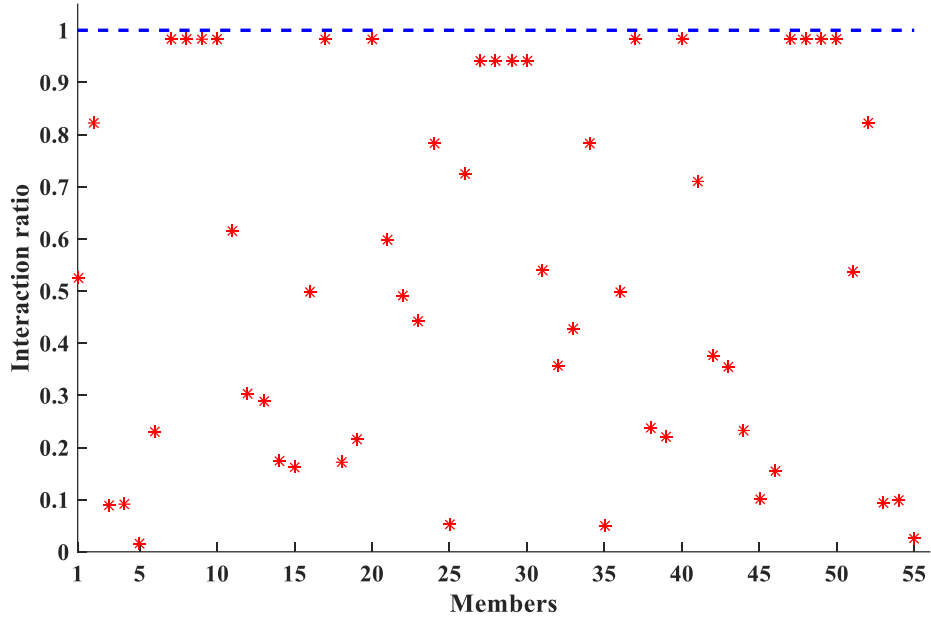

Figure 15. Members strength interaction ratio of 5×5 frame with with variable connections for mode 1

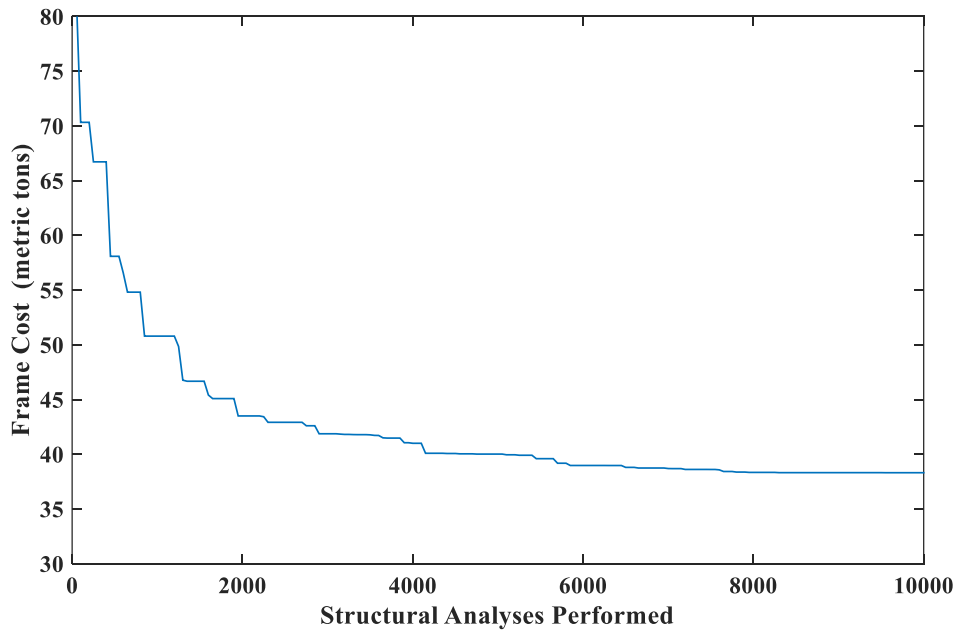

Figure 16. Convergence histories related to the best results of 5×5 frame with variable connections for mode 2

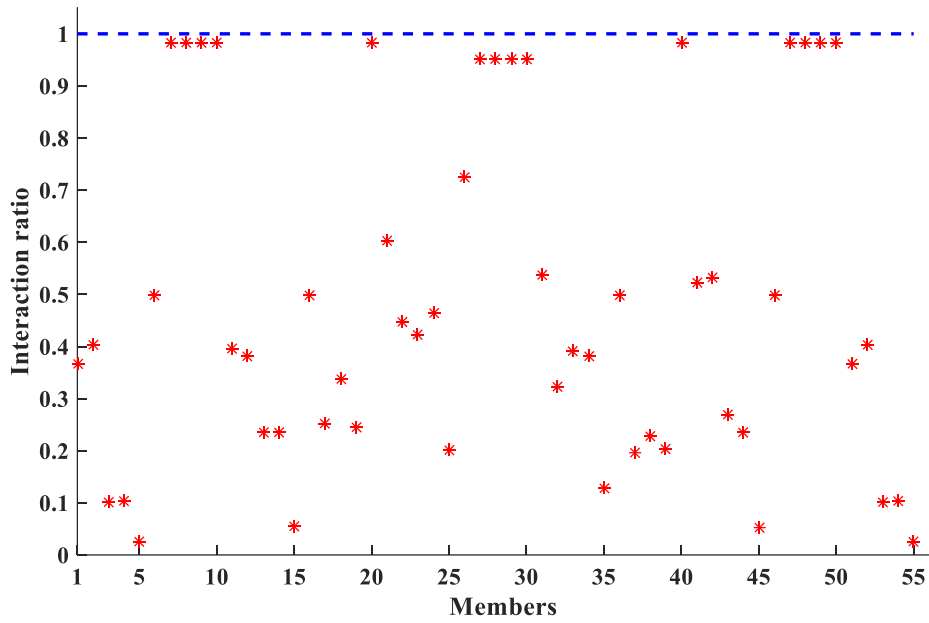

Figure17. Members strength interaction ratio of 5×5 frame with variable connections for mode 2

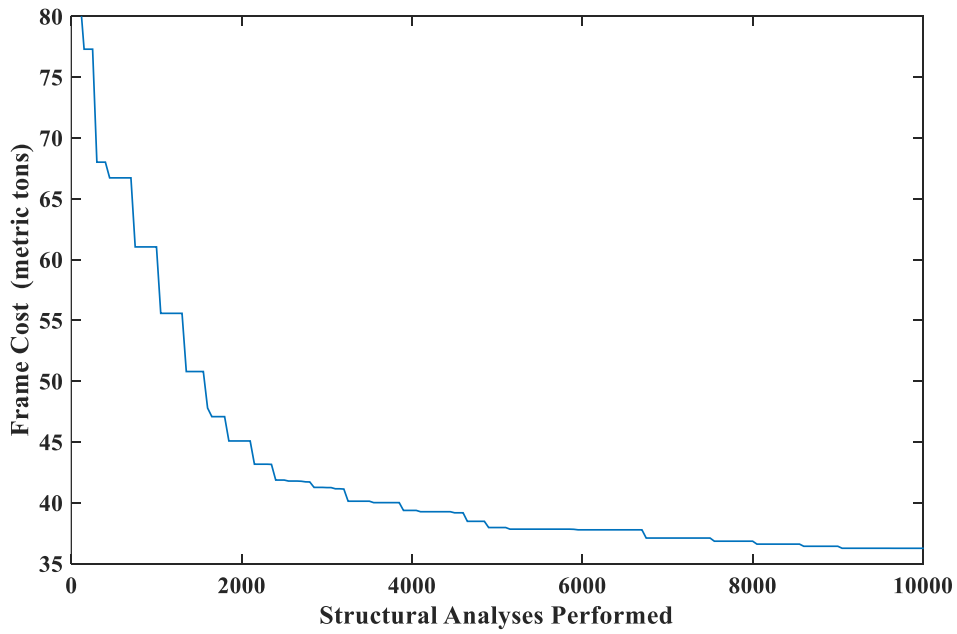

Figure 18. Convergence histories related to the best results of 5×5 frame with variable connections for mode 3

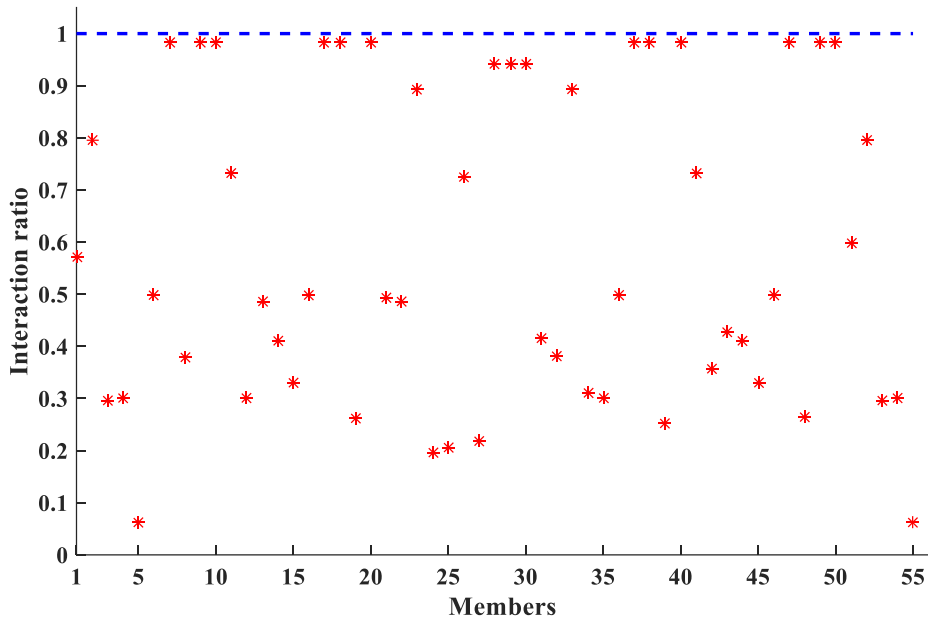

Figure 19. Members interaction ratio of 5x5 frame with variable connections for mode 3

Cost: 38.92 Metric Tons

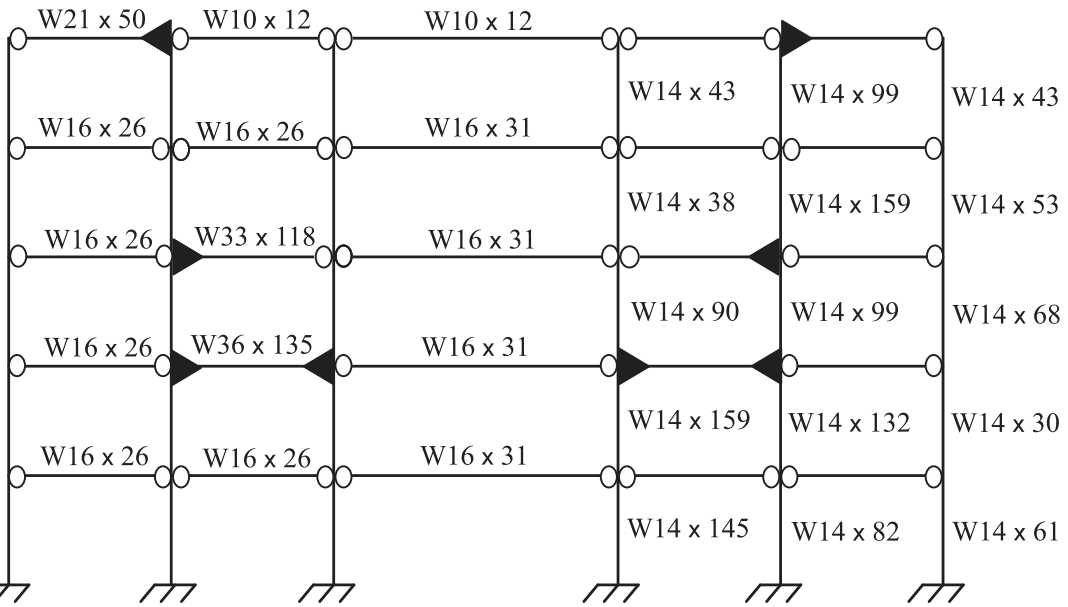

Figure 20. Best 5x5 designs from binary genetic algorithm with variable connection topology in two pools by including constraints

Cost: 38.31 Metric Tons

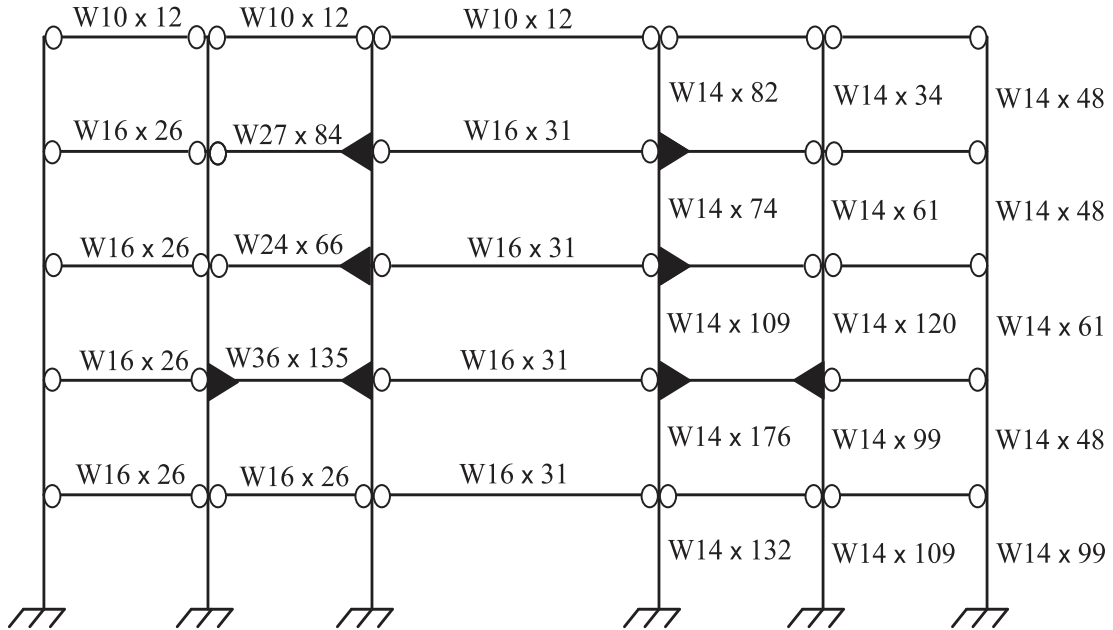

Figure 21. 5×5 designs from real genetic algorithm with variable connection topology in two pools by including constraints

Cost: 36.26 Metric Tons

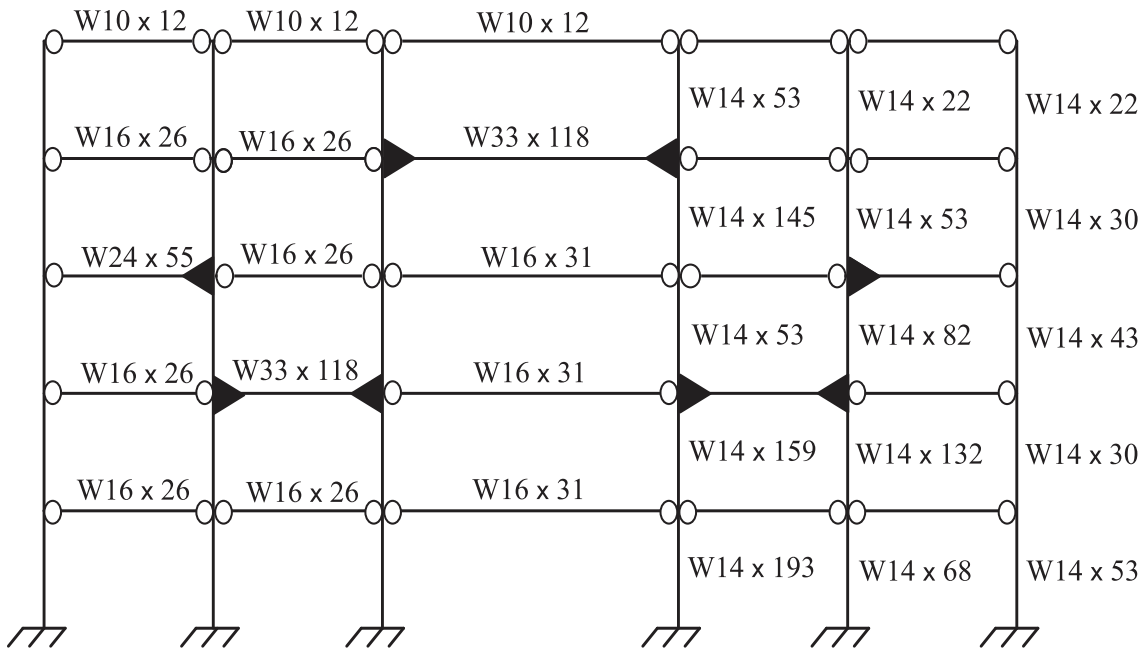

Figure 22. 5×5 designs from real genetic algorithm with variable connection topology in three pools by including constraints

To assess GA, total of 50 optimizations and 10,000 structural analyses are carried out. The optimization results with a comparison with Alberdi et al [12] applied algorithms presented in Table 10 and 11 for 5×5 and 5×10 frames, respectively.

Table 11. Optimization results for 5×10 frame with variable connection topology

| Costs(\$) reported in metric tons | Alberdi <i>et al.</i> [12] | | | | This study |
|---|----------------------------|-------|-------|-------------|------------|
| | ACO | TS | HS | GA (binary) | GA |
| Min. Cost (\$) | 143.9 | 142.8 | 214.5 | 158.7 | 150.9 |
| Avg. Cost (\$) | 167.1 | 174.1 | 248.5 | 188.4 | 181.5 |
| Std. Cost (\$) | 10.4 | 11.6 | 14.9 | 13.3 | 13.1 |
| No. of analyses | 20000 | 20000 | 20000 | 20000 | 20000 |
| No. of runs | 100 | 100 | 100 | 100 | 50 |

3.4 The 5×10 Frame with variable connection topology

Also, the optimum design for 5×10 frame with variable connection topology including all constraints presented in figure 23. This design example has been investigated by using the real genetic algorithm in three genetic pools (Third type mode) and the connections topology optimization has been considered in which each beam can be one of 4 types. the cost of beam-to-column connections also has been calculated. Table 11 compares the results of connection topology optimization by different methods reported by Alberdi et al. [12] As it can be seen, compared to the previously reported GA and HS algorithms, the proposed algorithm has obtained a plan with a lower cost, and the standard deviation and the corresponding mean are also lower. But compared to the other two algorithms, it has not performed well.

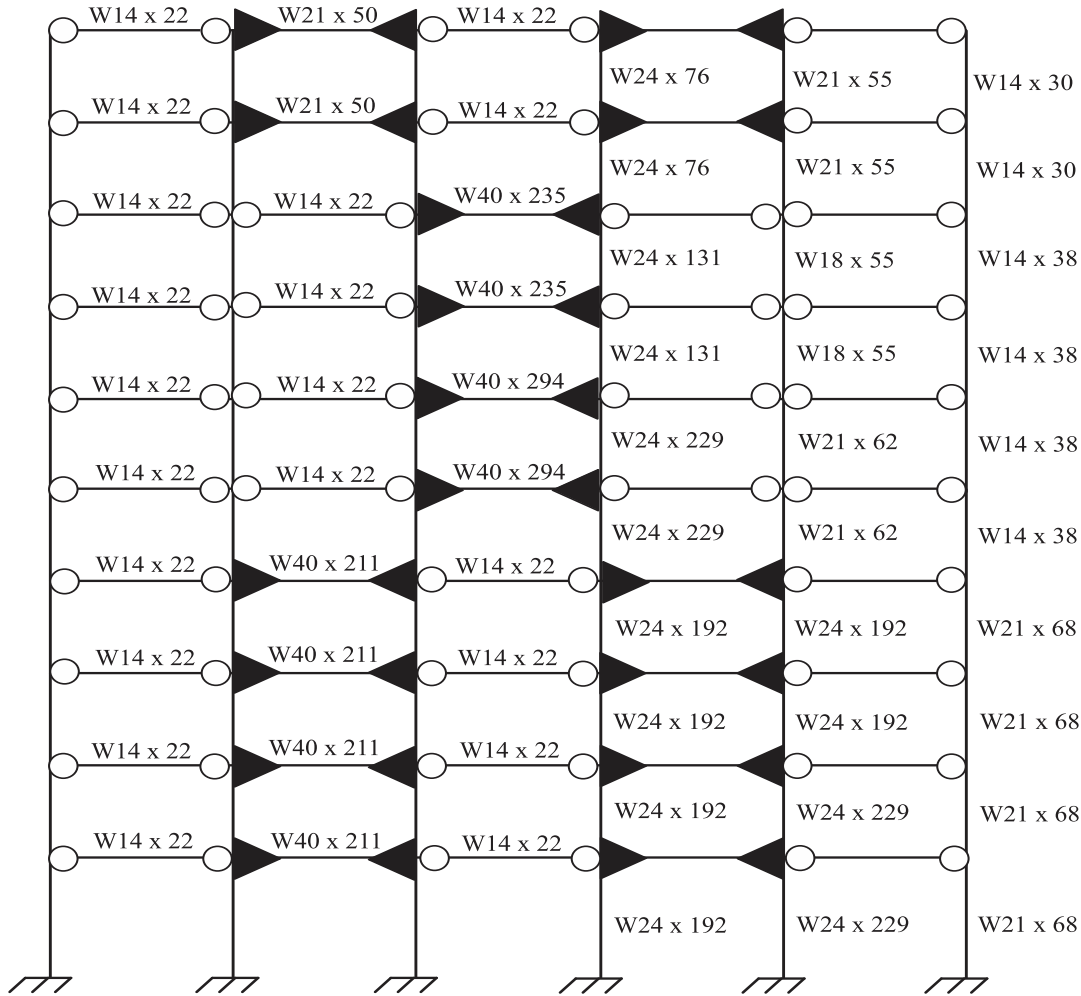
Cost: 150.90 Metric TonsFigure 23. 5×10 designs with variable connection topology by including constraints**4. CONCLUSION**

This study suggests that implementing topology optimization methods and genetic algorithms can lead to a reduction in the overall cost and weight of structures. Specifically, the results indicate that the steel frame optimization was most effective when multiple types of connections were used. Additionally, the study suggests that using a real genetic algorithm with three pools may be the most optimal approach for structural design. It seems using these novel approaches can be optimal for extending and investigating global designs and further researches should be done to reveal more aspects of the issue and outcomes.

Additionally, the application of the Taguchi method complements the computational approaches by providing a systematic and efficient experimental approach for selecting and The study analyzed four moment frames, and for the first two frames (3×2 and 8×1), the

objective was to optimize the structure by reducing its weight. The real genetic algorithm was utilized for these design examples, and the results showed that this algorithm performed well, particularly when compared to other methods such as the genetic algorithm in the binary field. What was important is the high speed of convergence and the low number of analysis structures of this algorithm in reaching the desired solution.

For two other moment frames (moment frame 5×5 and 5×10), with the aim of optimizing the structure by considering the cost related to the weight of the structure and connections between beams and columns, from the real genetic algorithm by making changes in the integration stage and Mutation is used. As we have seen, the cost of the structure in the case where all the joints in the moment frame are rigid compared to the case where the topology optimization of the joints, where the joints between the beam and the column can be any of the 4 types of beams (double-ended, double-jointed, left joint - right joint and left joint - right joint) are significantly increased, so we can see that it is possible to reduce the cost of the whole structure by considering various beam-to-column connections

For the moment frame 5×5 , three different modes were investigated and the results showed that the real genetic algorithm by applying changes in the integration and mutation shows a good performance and gives answers to Converge optimally with low standard deviation and mean. Applying mutation and integration for each chromosome in three separate pools increases the speed of convergence and the algorithm shows good stability according to the deviation of the obtained criteria.

So, in general, the use of this method, especially for the case where the objective function is dependent on various parameters and variables, shows a very favorable performance. Because in this method, control and mastery of different variables is done easily and good results are obtained.

REFERENCES

1. Munk DJ, et al. Multiobjective and multi-physics topology optimization using an updated smart normal constraint bi-directional evolutionary structural optimization method. *Struct Multidiscip Optim*, 2018;57:665-88.
2. Wang MY, Wang X, Guo D. A level set method for structural topology optimization. *Computer methods in applied mechanics and engineering*, 2003;192(1-2):227-46.
3. Querin OM, Steven GP, Xie YM. Evolutionary structural optimisation (ESO) using a bidirectional algorithm. *Eng Comput*. 1998;15(8):1031-48.
4. Mei L, Wang Q. Structural optimization in civil engineering: a literature review. *Buildings*, 2021;11(2): 10.3390/buildings11020066
5. Logan DL. *First Course in the Finite Element Method, Enhanced Edition, SI Version*. 2022: Cengage Learning.
6. Tsavdaridis KD, Kingman JJ, Toropov VV. Application of structural topology optimisation to perforated steel beams. *Comput Struct*, 2015;158:108-23.
7. Li Q. et al. Structural topology optimization considering connectivity constraint. *Struct Multidiscip Optim*, 2016;54(4):971-84.
8. Van Dijk NP, et al. Level-set methods for structural topology optimization: a review. *Struct Multidiscip Optim*, 2013;48(3):437-72.

9. Zhang XS, Paulino H, Ramos Jr AS. Multimaterial topology optimization with multiple volume constraints: Combining the ZPR update with a ground-structure algorithm to select a single material per overlapping set. *Int J Numer Methods Eng*, 2018;114(10):1053-73.
10. Esfandiari M, Urgessa G. Progressive collapse design of reinforced concrete frames using structural optimization and machine learning. in *Structures*. 2020. Elsevier.
11. Liu L, Yan J, Cheng G. Optimum structure with homogeneous optimum truss-like material. *Comput Struct*. 2008;86(13-14):1417-25.
12. Alberdi R, Murren P, Khandelwal K. Connection topology optimization of steel moment frames using metaheuristic algorithms. *Eng Struct* 2015;100:276-92.
13. Deaton JD, Grandhi RV. A survey of structural and multidisciplinary continuum topology optimization: post 2000. *Struct Multidiscip Optim*. 2014;49:1-38.
14. Kaveh A, Rahami H. Analysis, design and optimization of structures using force method and genetic algorithm. *Int J Numer Methods Eng*, 2006;65(10):1570-84.
15. Barmada S, et al. A deep learning surrogate model for topology optimization. *IEEE Trans Magnetics*, 2021; 57(6):1-4.
16. Bresolin JM, Pravia ZM, Kripka M. Discrete sizing and layout optimization of steel truss-framed structures with Simulated Annealing Algorithm. *Steel Compos Struct*, 2022;44(5):603.
17. Noilublao N, Bureerat S. Simultaneous topology, shape and sizing optimisation of a three-dimensional slender truss tower using multiobjective evolutionary algorithms. *Comput Struct*, 2011;89(23-24):2531-8.
18. Islam J, et al. A holistic review on artificial intelligence techniques for well placement optimization problem. *Adv Eng Softw*, 2020;141:102767.
19. AlRashidi M, El-Hawary M. Hybrid particle swarm optimization approach for solving the discrete OPF problem considering the valve loading effects. *IEEE Trans Power Syst*, 2007. 22(4):2030-8.
20. Wei L, et al. Truss optimization on shape and sizing with frequency constraints based on parallel genetic algorithm. *Struct Multidiscip Optim*, 2011;43:665-82.
21. Gülcü Ş, Training of the feed forward artificial neural networks using dragonfly algorithm. *Appl Soft Comput*. 2022;124:109023.
22. Kabiri Z, Barekatin B, Avokh A., GOP-SDN: an enhanced load balancing method based on genetic and optimized particle swarm optimization algorithm in distributed SDNs. *Wireless Networks*, 2022;28(6):2533-52.
23. Peng Z, et al., An improved energy-aware routing protocol using multiobjective particular swarm optimization algorithm. *Wireless Commun Mobile Comput*. 2021;2021:1-16.
24. Thomas S, Li Q, Steven G. Topology optimization for periodic multi-component structures with stiffness and frequency criteria. *Struct Multidiscip Optim*. 2020;61(6):2271-89.
25. Abdel-Basset M, Abdel-Fatah L, Sangaiah AK. Metaheuristic algorithms: A comprehensive review. *Computational Intell Multimedia Big Data Cloud Eng Appl*. 2018:185-231.
26. Pahnabi N, Seyedpoor SM, Damage identification in connections of moment frames using time domain responses and an optimization method. *Front Struct Civil Eng*, 2021;15(4):851-66.
27. He J, et al. Genetic algorithm for optimal placement of steel plate shear walls for steel frames. *Build*, 2022; 12(6):835.
28. Caserta M. Tabu search-based metaheuristic algorithm for large-scale set covering problems, in *Metaheuristics*. 2007, Springer. pp. 43-63.
29. Souлами KB, Saidi MN, Tamtaoui A.. A cad system for the detection of abnormalities in the

- mammograms using the metaheuristic algorithm particle swarm optimization (pso). in International Symposium on Ubiquitous Networking. 2016. Springer.
30. Dorigo M, Stützle T. Ant colony optimization: overview and recent advances. Handbook of Metaheuristics, 2019: pp. 311-351.
 31. Jh H. Adaptation in natural and artificial systems. Ann Arbor, 1975.
 32. Goldberg D. Genetic algorithms in search, Optimization and Machine Learning.-Addison-Wesley PC. 1989.
 33. Guest JK, Smith Genut LC. Reducing dimensionality in topology optimization using adaptive design variable fields. *Int J Numer Methods Eng*, 2010;81(8):1019-45.
 34. Vairavamoorthy K, Ali M Optimal design of water distribution systems using genetic algorithms. *Comput-Aided Civil Infrastruct Eng*, 2000;15(5):374-82.
 35. Degertekin SO, Hayalioglu MS, Harmony search algorithm for minimum cost design of steel frames with semi-rigid connections and column bases. *Struct Multidiscip Optim*, 2010;42(5):755-68.
 36. Kaveh A, Kalatjari V. Topology optimization of trusses using genetic algorithm, force method and graph theory. *Struct Multidiscip Optim*, 2003;58(5):771-91.
 37. Kaveh A, Khanlari K. Collapse load factor of planar frames using a modified genetic algorithm. *Commun Numer Methods Eng*. 2004;20(12):911-25.
 38. Kaveh A, Abdi-tehrani A. Design of frames using genetic algorithm, force method and graph theory. *Int J Numer Methods Eng*, 2004;61(14):2555-65.
 39. Degertekin S. Harmony search algorithm for optimum design of steel frame structures: a comparative study with other optimization methods. *Struct Eng Mech*. 2008;29(4):391-410.
 40. Rao SS. *Engineering Optimization: Theory and Practice*, 2009, John Wiley & Sons. 2009, Inc.
 41. Marafi A. *Optimization of Steel Moment Frame Using Harmony Search Algorithm*. 2020: Temple University.
 42. Saka MP, Geem ZW. Mathematical and metaheuristic applications in design optimization of steel frame structures: an extensive review. *Math Prob Eng*;2013. 2013.
 43. Kaveh A. Shahrouzi M. Simultaneous topology and size optimization of structures by genetic algorithm using minimal length chromosome. *Eng Comput*. 2006;23(6):644-74.
 44. Serhat G, Basdogan I. Multi-objective optimization of composite plates using lamination parameters. *Mater Des*, 2019;180:107904.
 45. Construction, A.I.o.S., *Manual of steel construction: load & resistance factor design*. 2001: Amer Inst of Steel Construct.
 46. Pezeshk S, Camp C, Chen D Design of nonlinear framed structures using genetic optimization. *J Struct Eng*, 2000;126(3):382-88.
 47. Camp CV, Bichon BJ, Stovall SP. Design of steel frames using ant colony optimization. *J Struct Eng*, 2005;131(3):369-79.
 48. Toğan V, Design of planar steel frames using teaching–learning based optimization. *Eng Struct*. 2012;34:225-32.
 49. Khot N., Venkayya V, Berke L. Optimum structural design with stability constraints. *Int J Numer Methods Eng*, 1976;10(5):1097-114.
 50. Camp C, Pezeshk S, Cao G. Optimized design of two-dimensional structures using a genetic algorithm. *J Struct Eng*, 1998;124(5):551-9.
 51. Kaveh A, Shojaee S. Optimal design of skeletal structures using ant colony optimization. *Int J Numer Methods Eng*, 2007;70(5):563-81.